

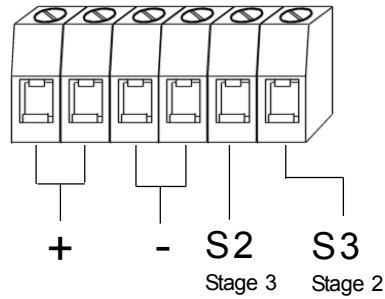

MBL1 - L.E.D Marine grade IP66 & IP67 Beacons & Status Lights

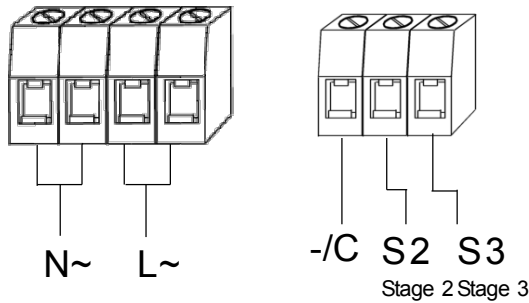

DC units

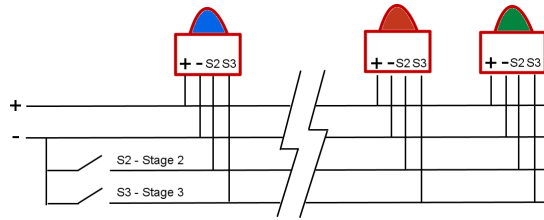

AC units

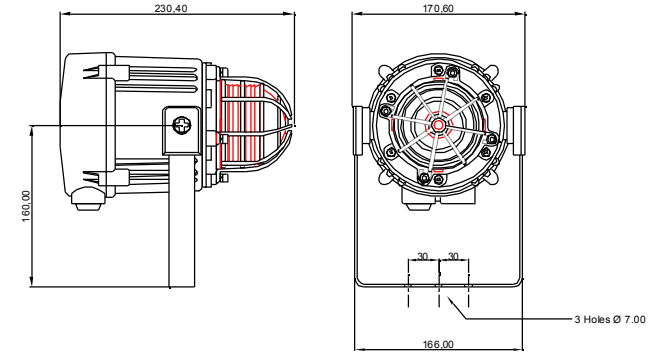
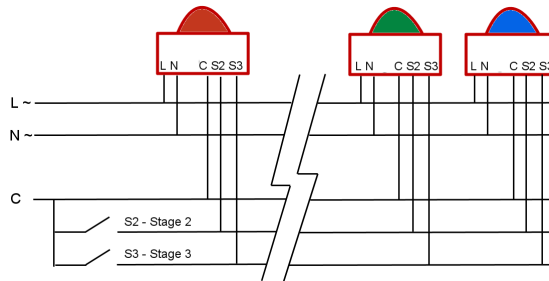

Voltage :	24vdc	48vdc	115vac	230vac	24vac
			50/60Hz	50/60Hz	50/60Hz
Voltage range :	10-50vdc	10-50vdc	+/-10%	+/-10%	+/-10%
Current mA :	400mA	230mA	140mA	70mA	380mA

Stage 1	L.E.D Pattern Description	Stage 2	Stage 3
1	All on	9	8
2	Single strike strobe 2Hz	9	1
3	Rotating 6 LED on Slow	7	1
4	Rotating 3 LED on Slow	3	1
5	Rotating 6 LED on Fast	6	1
6	Double strike strobe 1Hz	7	1
7	Rotating 3 LED on Fast	8	1
8	Double strike strobe 2Hz	9	1
9	Alternate side flash 1:1 2Hz	7	1

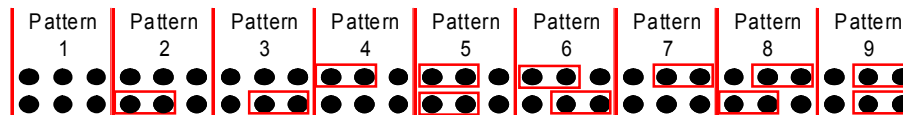
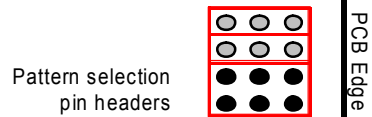



ATTENTION

- Disconnect from power source to prevent electrical shock before installing and servicing
- Couper l'alimentation pour empêcher tout choc électrique avant d'effectuer des travaux d'installation et d'entretien.
- Vor der Installation und Wartung von der Spannungsquelle abnehmen, um elektrische Schläge zu vermeiden.
- Prima dell'installazione e della manutenzione spegnere l'alimentazione elettrica per evitare scosse elettriche.
- Desconecte la alimentación para evitar descargas eléctricas antes de la instalación y mantenimiento
- Antes de instalar ou de fazer a manutenção desligue sempre da alimentação eléctrica para evitar choques eléctricos.
- Strømmen skal afbrydes ved installering og eftersyn for at undgå elektrisk stød.
- Los koppel en van de elektrische voeding om elektrische schok vóór installatie en onderhoud te voorkomen.
- Før monteringen eller vedligehold, må spændingen koples fra for å unngå strømstøt.
- Bryt strømmen innan installation och underhåll för att förhindra elektriska stötar stötar.